

Easy steps for best Pure 2 Edge screen protector installation.

Pure 2 Edge Family

- 1 Remove old protector and case to clean phone screen with alcohol wipe and cleaning cloth. Then remove dust with large dust removal sticker.

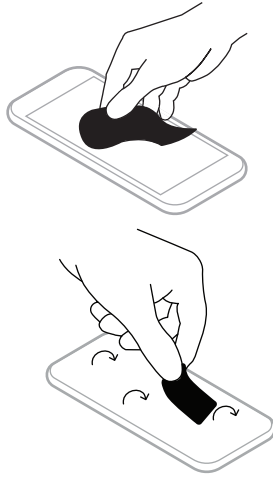

- 2 Place install guide over phone.

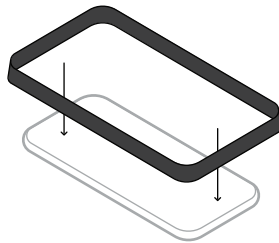

- 3 Check screen again and remove any dust using large dust removal sticker.



- 4 Remove new protector from plastic backing. Line up protector at one end of screen and lay onto phone.

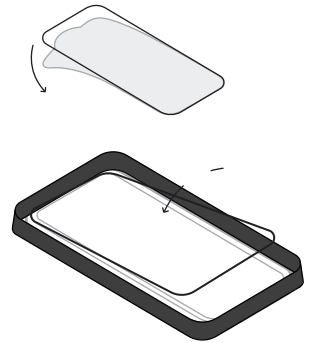

- 5 Use cleaning cloth to push out big bubbles, use smaller dust removal stickers to get any dust specks under protector.

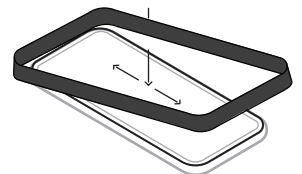

- 6 Take pride in your good work!

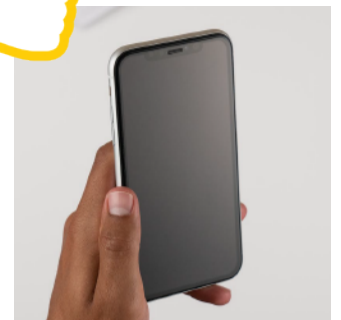

Still need some help with your install? Visit the BodyGuardz YouTube Channel for a variety of Installation videos: <http://www.youtube.com/bodyguardz>

Easy steps for best PRTX screen protector installation.

PRTX Family

- 1** Remove old protector and case to clean phone screen with alcohol wipe and cleaning cloth. Then remove dust with large dust removal sticker.

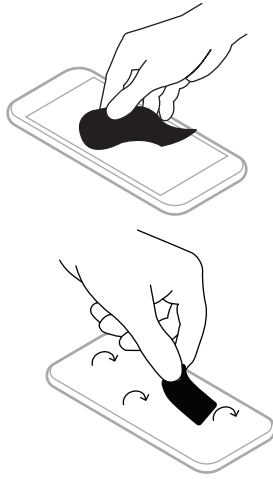

- 2** Place install guide over phone.

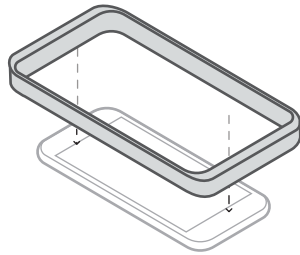

- 3** Check screen again and remove any dust using large dust removal sticker.

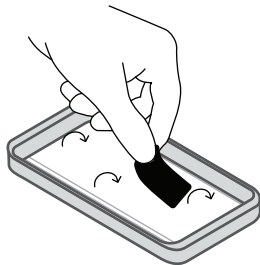

- 4** Remove new protector from plastic backing. Line up protector at one end of screen and use squeegee to lay onto phone.

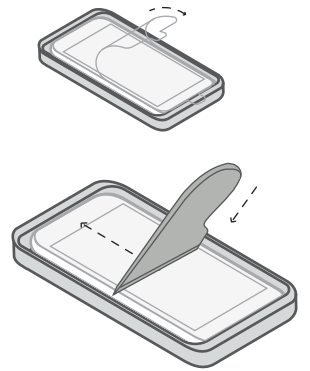

- 5** Use squeegee to push out any big bubbles, use smaller dust removal stickers to get any dust specks under protector.

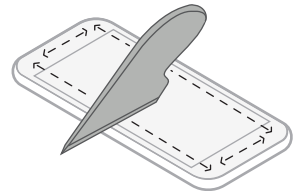

- 6** Take pride in your good work!

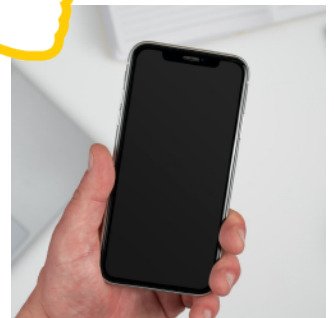

Still need some help with your install? Visit the BodyGuardz YouTube Channel for a variety of Installation videos: <http://www.youtube.com/bodyguardz>