

**EXPRESS ALIGN  
INSTALL**

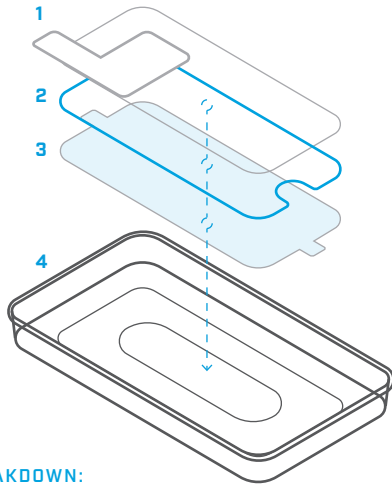

**BREAKDOWN:**

- 1 RELEASE LINER**  
A clear film that protects the adhesive side of the protector.
- 2 GLASS PROTECTOR**  
The thin, ultra-strong glass that will protect your device.
- 3 CAP SHEET**  
A clear film that protects the anti-smudge coating on the glass.
- 4 EXPRESS ALIGN TRAY**  
This plastic tray precisely aligns the glass to your device.

**OPEN TO GET STARTED** →

**! BEFORE YOU BEGIN**

- Remove case from your phone (if any)
- Place phone on a flat surface, screen-up
- Clean your phone's screen thoroughly
- Watch our install video: [bodyguardz.com/install](http://bodyguardz.com/install)

**PRO TIPS**

**DUST REMOVAL AFTER INSTALLATION:**

Use the provided dust removal stickers to pull out any trapped dust. Carefully lift up the corner of the glass closest to the dust particle and place the sticky side of the strip against the piece of dust. Then, pull dust sticker straight out.

**TO REMOVE PROTECTOR:**

Carefully lift one corner and slowly pull the glass off your device.

**1** While holding the tray, peel off the release liner to expose the adhesive, then place the tray on top of your device.

Check orientation of phone and protector

**2** Through the opening in the tray, firmly press and hold the glass protector down with your fingers, while pulling the tray off with your other hand.

Tray will come off and protector will adhere to phone

**3** Use the included cleaning cloth to push out any bubbles, then peel off the cap sheet.

Extra bubbles will disappear within 24-48 hrs.

**Nice Work!**  
Installation is complete.

# BODYGUARDZ PURE®/PURE 2®/SPYGLASS® WITHOUT EXPRESS ALIGN®

## INSTALLATION INSTRUCTIONS

# BODYGUARDZ®

### ⊗ **DUST IS THE ENEMY**

Before you begin installation, use the provided microfiber cloth and dust stickers to thoroughly clean the screen of your device.

INSTALL VIDEO:  
[bodyguardz.com/install](http://bodyguardz.com/install)

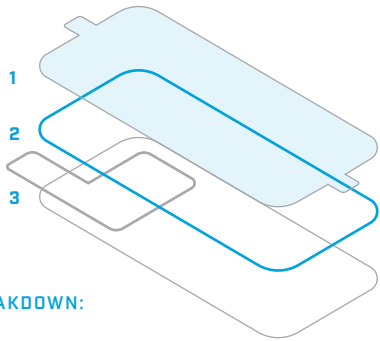

#### BREAKDOWN:

- 1 CAP SHEET**  
A clear film that protects the anti-smudge coating on the glass.
- 2 GLASS PROTECTOR**  
The thin, ultra-strong glass that will protect your device.
- 3 RELEASE LINER**  
A clear film that protects the adhesive side of the protector.

1

Hold the edges of the protector and peel off the release liner.

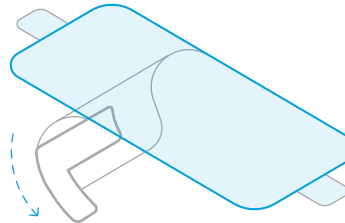

2

Align the protector over your device and gently lay it down.

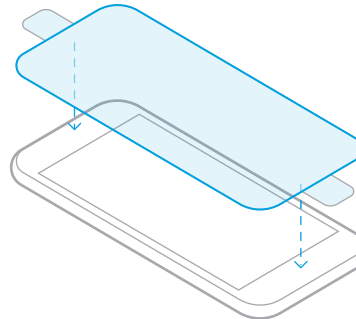

3

Press down on the center of the protector to adhere it to the screen.

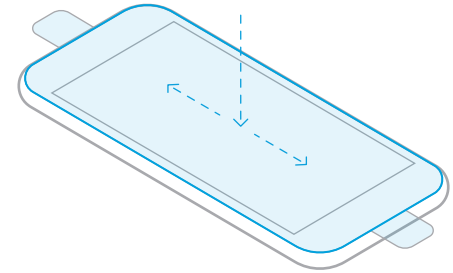

4

Use the included cleaning cloth to push out any bubbles, then peel off the cap sheet.

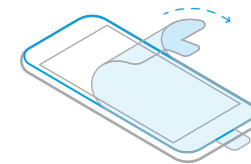

Extra bubbles will disappear within 24-48 hrs.

**Nice Work!**  
Installation is complete.

### PRO TIPS

#### DUST REMOVAL AFTER INSTALLATION:

Use the provided dust removal stickers to pull out any trapped dust. Carefully lift up the corner of the glass closest to the dust particle and place the sticky side of the strip against the piece of dust. Then, pull dust sticker straight out.

#### TO REMOVE PROTECTOR:

Carefully lift one corner and slowly pull the glass off your device.

## HD INSTALLATION

Clean your device screen and wash your hands before installation.

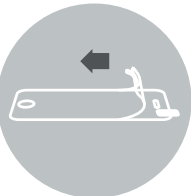

- 

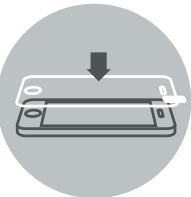
1 Peel the back liner (c) off, exposing the adhesive side of the film. Be careful not to touch the adhesive.
- 

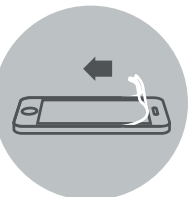
2 Position the film (b) over the device using edges, buttons and camera to judge the alignment. When it is aligned, press down on the middle of the protector.
- 

3 Push out any bubbles, then carefully remove the cap sheet (a).

Extra bubbles will disappear within 24-48 hours.

# ULTRATOUGH INSTALLATION

for smartphones & tablets

## MAKE YOUR INSTALL EASIER

Watch installation videos:  
[bodyguardz.com/install](http://bodyguardz.com/install)

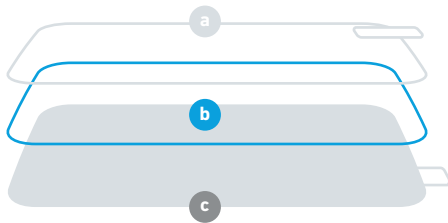

- a** **Cap Sheet**  
Clear, rigid sheet covering the protective film
- b** **UltraTough Protector**  
Film that protects your device
- c** **Back Liner**  
White sheet protecting adhesive side of film

**IMPORTANT:** Follow the instructions carefully. There are two methods to install your protector — with or without the application gel.



### GEL APPLICATION

The gel application method allows you to more easily position your protector and minimizes bubbles. Although it requires about 30 minutes to dry before use, there will be significantly less haze than the dry method immediately after application. We recommend waiting overnight before putting your device in a case or bag, as it will take up to 72 hours to completely cure.



### DRY APPLICATION



The dry apply method offers a quicker application, although your protector cannot be repositioned once it is applied. As the adhesive cures, there will be a visible haze immediately following application, but it should completely cure within 96 hours. Your device will be ready for use immediately after application. However, we recommend waiting overnight before putting it in a case or bag.

### PREPARATION

Turn your device off, wash your hands, and clean your device with provided cleaning cloth.

*NOTE: Illustrations do not necessarily represent your device.*

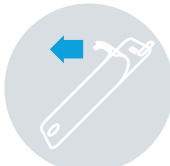
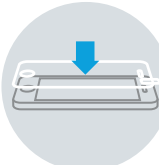
### GEL APPLICATION INSTRUCTIONS

- 1**  Remove the film from the white back liner (c). Using your finger, spread application gel over the entire sticky side of the film. Only a few drops of gel are needed.
- 2**  Put the protector on the device, reposition by placing your fingers on the film and gliding it into the correct position.
- 3**  Using a credit card covered with the provided cleaning cloth, squeegee from the middle to remove all bubbles and excess gel.
- 4** Let sit for 20 minutes, then carefully remove the cap sheet (a) by pulling on the BodyGuardz tab. Any haziness will disappear over time.

**FOR FULL-BODY:** Repeat process for back protector, and apply any side pieces by peeling them off the back liner (c) and placing them according to included diagram (no gel is needed for side pieces).

### DRY APPLICATION INSTRUCTIONS

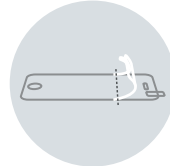
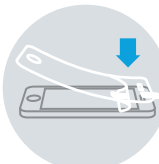
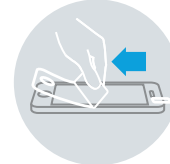
- 1**  With the film facing down, peel back the white liner (c) 1-1.5 inches from the top and crease the liner, exposing the adhesive side of the film. Be careful not to touch the adhesive.
- 2**  Position the film over the device using edges, buttons and camera to judge the alignment. When the protector is aligned, press down on the exposed adhesive portion.
- 3**  Using a credit card, press down the remaining portion of the film, letting the back liner slip away. Rub the surface with card or cleaning cloth to smooth out any bubbles.
- 4** Carefully remove the cap sheet (a) by pulling on the BodyGuardz tab. Any haziness will disappear over time.

**FOR FULL-BODY:** Repeat process for back protector, and apply any side pieces by peeling them off the back liner (c) and placing them according to included diagram.

# ARMOR™ CARBON FIBER INSTALLATION INSTRUCTIONS

# BODYGUARDZ®

Thanks to air-release technology, **installation is very easy.** Air-release adhesive makes it easy to push out any air bubbles after installation. Plus, if the protector is not aligned perfectly, just carefully remove it and try again.



1 Lay your device screen-down on a flat surface. Carefully remove the armor skin from the white back liner.

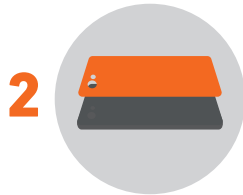

2 While holding the edges of the skin, align it with your device using the edges, buttons and camera.

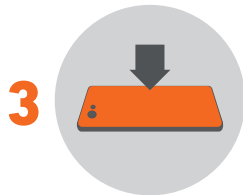

3 Once aligned, press the adhesive side of the skin to your device. Press down corners or edges that are sticking up and smooth out any bubbles with your fingers.

*If there are any side pieces included, see enclosed diagram for placement. Be careful not to stretch the material.*

## SPECIAL NOTE FOR APPLE® DEVICES

If you are applying armor to an Apple device, you may have an optional cutout for the Apple logo. This cutout can be used to cover your device completely, if desired.

We highly recommend watching our install videos:

[youtube.com/bodyguardz](https://www.youtube.com/bodyguardz)



For more information and to register your product go to:

[bodyguardz.com/advantage\\_program](https://www.bodyguardz.com/advantage_program)



[bodyguardz.com](https://www.bodyguardz.com)



[facebook.com/bodyguardz](https://www.facebook.com/bodyguardz)



[@bodyguardz](https://twitter.com/bodyguardz)

# ULTRATOUGH INSTALLATION

for MacBook®

## PREPARATION

Turn your device off, wash your hands, and clean your device with provided cleaning cloth.

## APPLICATION GEL

The gel allows you to more easily position your protector and minimizes bubbles. Although it requires about 30 minutes to dry before use, there will be significantly less haze. We recommend waiting overnight before putting your device in a case or bag, as it will take up to 72 hours to completely cure.

## INSTALLATION TIPS

- Apply the wrist rest portions first. These are the easiest pieces to install.
- When applying the bottom, use the back screw holes to properly align the protector.

## QUESTIONS?

support@bodyguardz.com



### MAKE YOUR INSTALL EASIER

Watch the installation video:  
<https://youtu.be/ORL1vWxkJ-Y>

Included items needed: a squeegee card, a cleaning cloth, and application gel

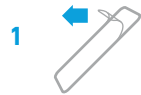

1

Remove the film from the white back liner. Using your finger, spread application gel over the entire sticky side of the film.



2

Place the protector on the device, reposition by placing your fingers on the film and gliding it into the correct position.



3

Using the included squeegee card, or a credit card, covered with the provided cleaning cloth, squeegee from the middle to remove all bubbles and excess gel.



4

Repeat process for all the pieces of the protector.



5

Let sit for 30 minutes. Any haziness will disappear over time.



6

Learn more and register your product at:  
[bodyguardz.com/advantage\\_program](http://bodyguardz.com/advantage_program)

**BODYGUARDZ**  
THE ULTIMATE DEVICE PROTECTION®